



Ficha técnica do produto

Datasheet / Ficha técnica del producto

Data: 16.06.2023

Versão: 3.0

IN.16.020

Conchas/
Flush handles/ Cazoletas

ET:3544/2022

Documento confidencial / Confidential document / Documento confidencial @ JNF 2023 www.jnf.pt

Descrição / Description / Descripción
Versão / Version / Versión
Data / Date / Data
Material / Material / Material
Acabamento / Finish / Acabado

Concha / Flush handle / Cazoleta
3.0
16.06.2023
Aço Inox / Stainless steel / Acero Inox - EN 1.4301
Satinado / Satin / Satin

Outros acabamentos/
Other finishes/ Otros acabados

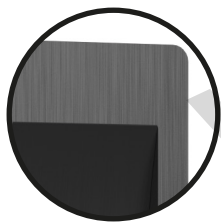

.TB
TITANIUM BLACK



.TCH
TITANIUM CHOCOLATE

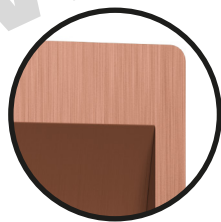

.TCO
TITANIUM COPPER



.TG
TITANIUM GOLD



IN.16.020.120



IN.16.020.200

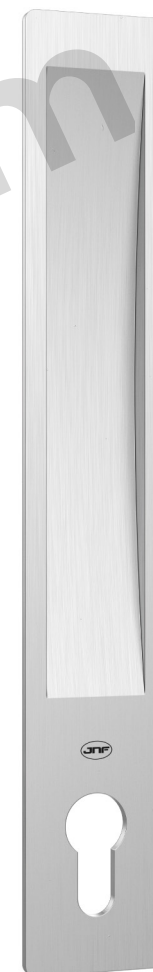

IN.16.020.200.PZ



Ficha técnica do produto

Datasheet / Ficha técnica del producto

Data: 16.06.2023

Versão: 3.0

IN.16.020.120

Conchas/
Flush handles/ Cazoletas

ET:3544/2022

Documento confidencial / Confidential document / Documento confidencial @ JNF 2023 www.jnf.pt

Descrição / Description / Descripción

Concha / Flush handle / Cazoleta

Versão / Version / Versión

3.0

Data / Date / Data

16.06.2023

Entalhe / Door cut / Taladro

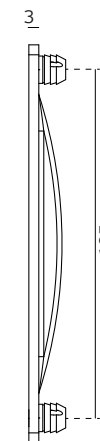
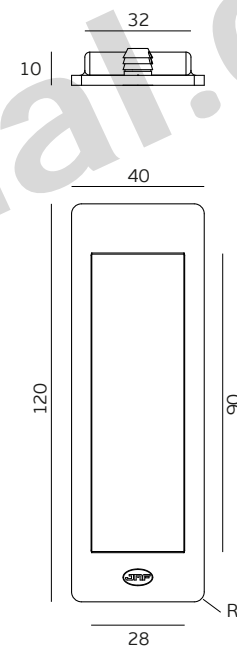
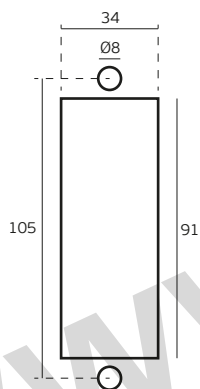



Ficha técnica do produto

Datasheet / Ficha técnica del producto

Data: 16.06.2023

Versão: 3.0

IN.16.020.200

Conchas/
Flush handles/ Cazoletas

ET:3544/2022

Documento confidencial / Confidential document / Documento confidencial @ JNF 2023 www.jnf.pt

Descrição / Description / Descripción

Concha / Flush handle / Cazoleta

Versão / Version / Versión

3.0

Data / Date / Data

16.06.2023

Entalhe / Door cut / Taladro

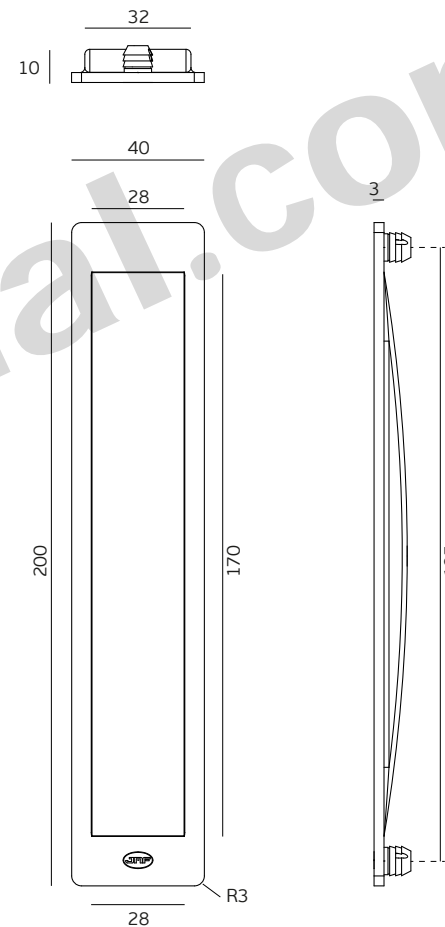
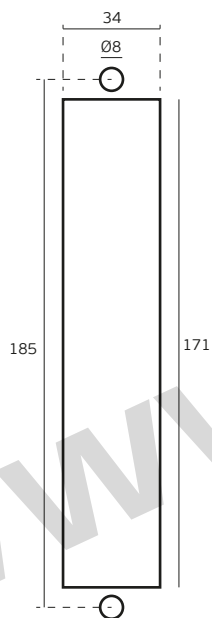



Ficha técnica do produto

Datasheet / Ficha técnica del producto

Data: 16.06.2023

Versão: 3.0

IN.16.020.200.PZ

Conchas/
Flush handles/ Cazoletas

ET:3544/2022

Documento confidencial / Confidential document / Documento confidencial @ JNF 2023 www.jnf.pt

Descrição / Description / Descripción	Concha / Flush handle / Cazoleta
Versão / Version / Versión	3.0
Data / Date / Data	16.06.2023

Entalhe / Door cut / Taladro

