



## Ficha técnica do produto

Datasheet / Ficha técnica del producto

Data: 31.10.2023

Versão: 4.0

## IN.05.061

Dobradiças/  
Hinges/ Bisagras

ET:1655/2016

Documento confidencial / Confidential document / Documento confidencial @ JNF 2023 www.jnf.pt

Descrição / Description / Descripción

Dobradiça oculta com ajuste 3D - COPLAN 150 /

Concealed hinge with 3D adjustment - COPLAN 150 /

Bisagra oculta con ajuste 3D - COPLAN 150 /

Versão / Version / Versión

4.0

Data / Date / Data

31.10.2023

Material / Material / Material

Liga de Zinco / Zinc Alloy / Aleación de Zinc

Acabamento / Finish / Acabado

Pintado / Painted / Pintado - RAL 9006

Acessórios / Accessories / Accesorios

4x - Tampas / Covers / Cubiertas

8x - Parafusos / Screws / Tornillos - DIN 7997 - Ø5x30mm

1x - Chave Allen / Allen key / Llave Allen - 3mm

1x - Chave Allen / Allen key / Llave Allen - 4mm

Info. Embalagem / Package / Embalaje

Código de barras/

Bar code/

Código de barras



5 1602686 1038251



5 1602686 1538256

Unidade/ Unit/ Unidad

1 Un.

24 Un.

Peso/ Weight/ Peso

0,55 kg

14 kg

Medidas/ Dimensions/ Dimensiones

165 x 60 x 30 mm

330 x 130 x 195 mm

Embalagem/ Package/ Embalaje

CA403

Caixa / Box / Caja

Outros acabamentos/

Other finishes/ Otros acabados



.B  
BLACK COATED



.SG  
GOLD COATED



.SC  
COPPER COATED



.W  
WHITE COATED



MAINTENANCE  
FREE



100.000 CYCLES

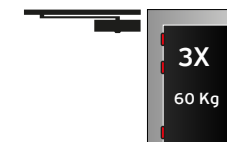

200.000 CYCLES



100.000 CYCLES



FIREPROOF

IN.05.061 + KI.05.061  
Dobradiça invisível com ajuste 3D + KIT intumescente  
3D Adjustable invisible hinge + Intumescent KIT

EN1935 2 7 2 0 1 4 0 7

EN1935 2 7 2 1 1 4 0 7



## Ficha técnica do produto

Datasheet / Ficha técnica del producto

Data: 31.10.2023

Versão: 4.0

## IN.05.061

Dobradiças/  
Hinges/ Bisagras

ET:1655/2016

Documento confidencial / Confidential document / Documento confidencial @ JNF 2019 www.jnf.pt

Descrição / Description / Descripción

Dobradiça oculta com ajuste 3D - COPLAN 150 /

Concealed hinge with 3D adjustment - COPLAN 150 /

Bisagra oculta con ajuste 3D - COPLAN 150 /

Versão / Version / Versión

4.0

Data / Date / Data

31.10.2023

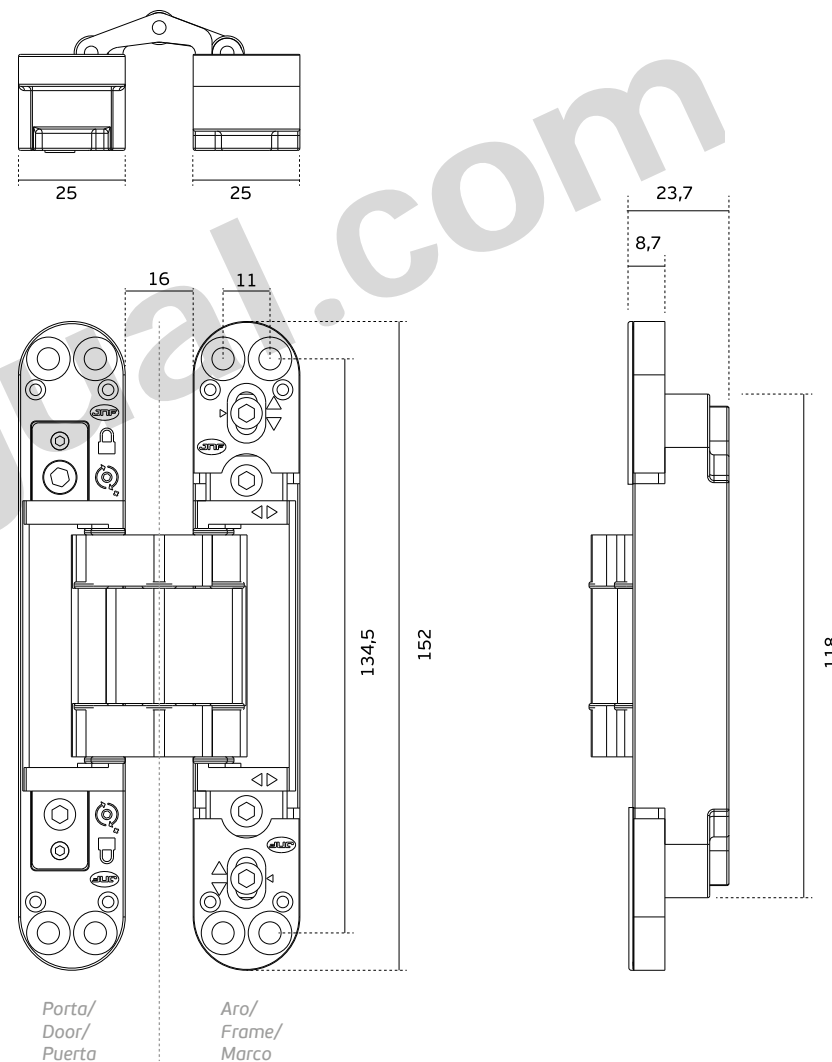
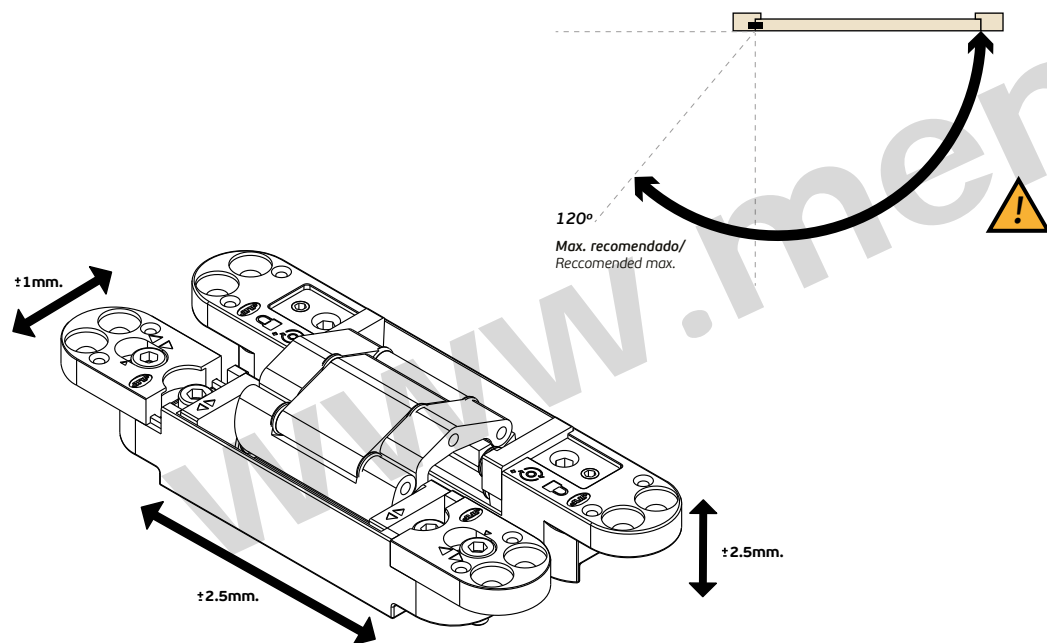



## Ficha técnica do produto

Datasheet / Ficha técnica del producto

Data: 31.10.2023

Versão: 4.0

## IN.05.061

Dobradiças/  
Hinges/ Bisagras

ET:1655/2016

Documento confidencial / Confidential document / Documento confidencial @ JNF 2023 www.jnf.pt

Descrição / Description / Descripción	Dobradiça oculta com ajuste 3D - COPLAN 150 / Concealed hinge with 3D adjustment - COPLAN 150 / Bisagra oculta con ajuste 3D - COPLAN 150 /
Versão / Version / Versión	4.0
Data / Date / Data	31.10.2023

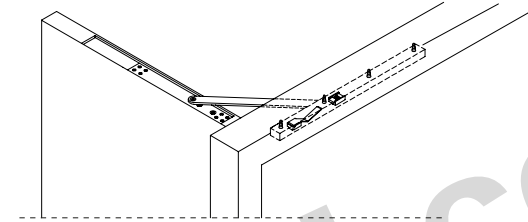

Não recomendado o uso de molas de porta com sistema de retenção/  
Not recommended to use door closers with hold open system/  
No se recomienda utilizar cierrapuertas con sistema de retención

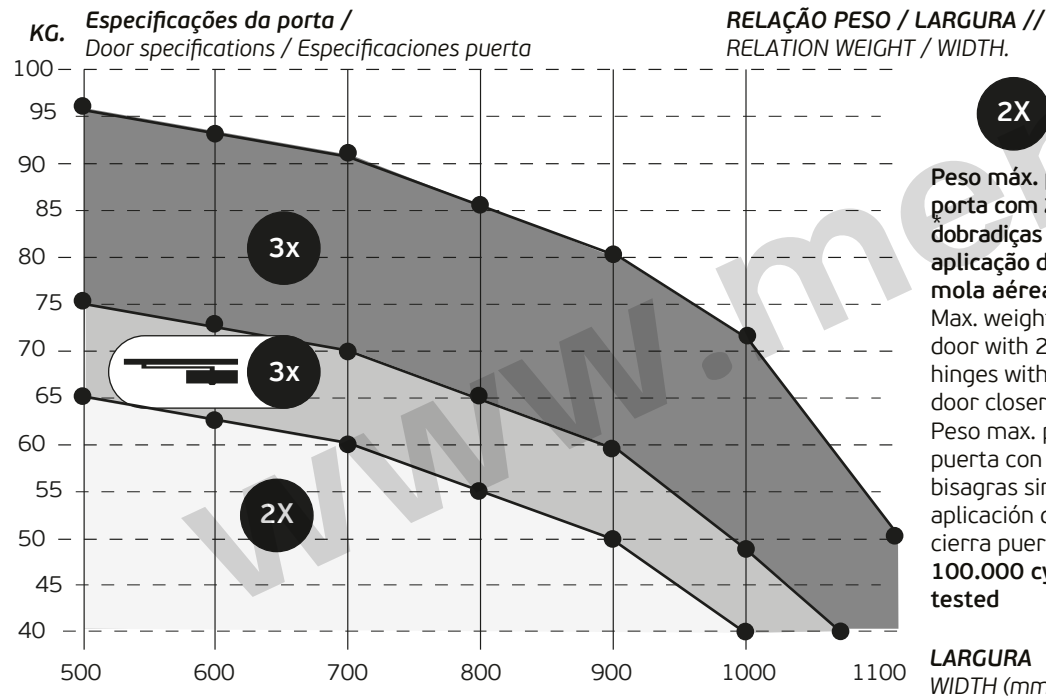

**Distribuição /**  
Distribution / Distribución

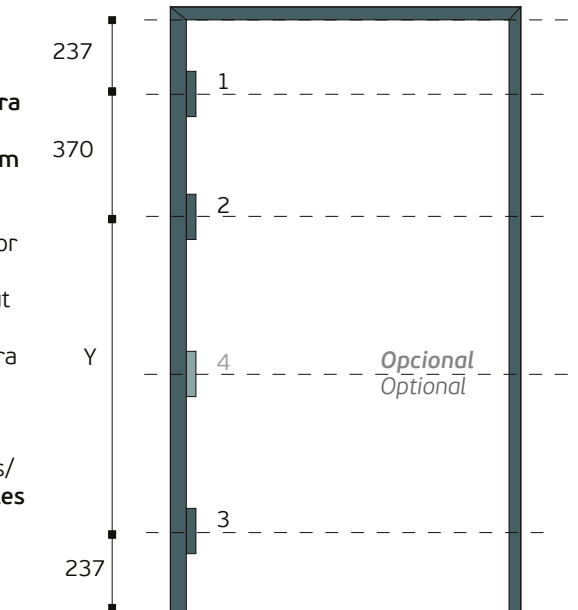



## Ficha técnica do produto

Datasheet / Ficha técnica del producto

Data: 31.10.2023

Versão: 4.0

## IN.05.061

Dobradiças/  
Hinges/ Bisagras

ET:1655/2016

Documento confidencial / Confidential document / Documento confidencial @ JNF 2023 www.jnf.pt

Descrição / Description / Descripción	Dobradiça oculta com ajuste 3D - COPLAN 150 / Concealed hinge with 3D adjustment - COPLAN 150 / Bisagra oculta con ajuste 3D - COPLAN 150 /
Versão / Version / Versión	4.0
Data / Date / Data	31.10.2023

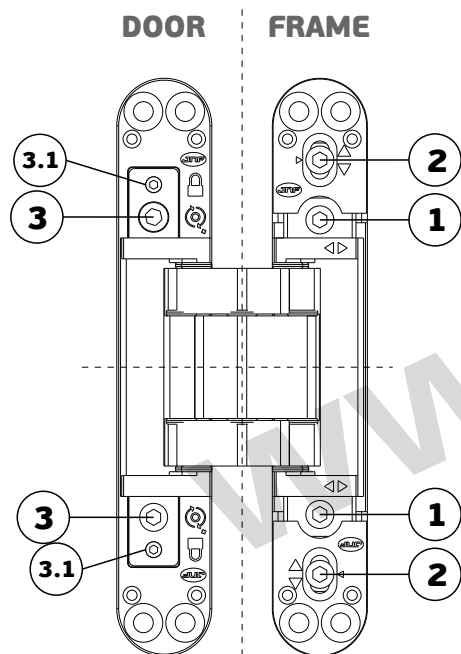

- 1 Ajuste em profundidade. Aliviar os 2 parafusos de cada dobradiça. Ajustar a posição da porta. Apertar todos os parafusos, torque 3 N/m. /**  
Depth adjustment. Loose the 2 screws of each hinge. Adjust the position of the door. Tighten all screws, torque 3 N/m. /  
Ajuste de profundidade. Afloje los 2 tornillos de cada bisagra. Ajuste la posición de la puerta. Apriete todos los tornillos, esfuerzo de torsión 3 N/m.
- 2 Ajuste vertical. Aliviar os 2 parafusos de cada dobradiça. Inserir um calço na parte inferior da porta com a folga pretendida. Apertar todos os parafusos, torque 3N/m. /**  
Vertical adjustment. Loose the 2 screws of each hinge. Place a shim in the lower part of the door with the desired gap. Tighten all screws, torque 3 N/m. /  
Ajuste vertical. Afloje los 2 tornillos de cada bisagra. Coloque la cuña en la parte inferior de la puerta con el hueco deseado. Apriete todos los tornillos, esfuerzo de torsión 3 N/m.
- 3 Ajuste horizontal. Aliviar os parafusos (3.1) de cada dobradiça. Rodar alternadamente os parafusos (3) de forma a conseguir a folga desejada. Para bloquear o ajuste apertar todos os parafusos (3.1), torque 3 N/m. /**  
Horizontal adjustment. Loose the screws (3.1) of each hinge. Turning alternately the screws (3) in order to achieve the desired gap. To lock the adjustment tighten all the screws (3.1). Torque 3 N/m. /  
Ajuste horizontal. Afloje los tornillos (3.1) de cada bisagra. Rodar alternativamente los tornillos (3) con el fin de lograr el separación deseada. Para bloquear el ajuste de apretar todos los tornillos (3.1) esfuerzo de torsión 3 N / m. /

### ENTALHE / CUT OUT / TALADRO

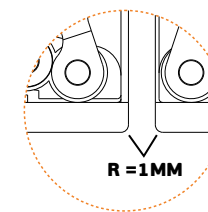
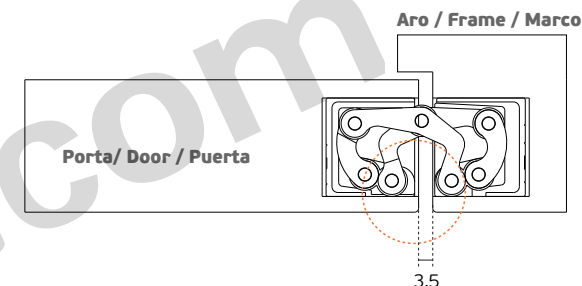
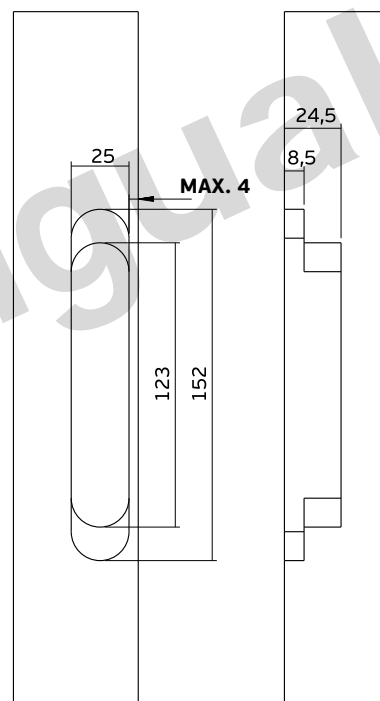

**WARNING R =1MM ( MIN.)**

### Aro / Frame / Marco

