

LAMP**HES**
Hinge - Expert**INSTALLATION MANUAL****FOR HES2S-140-A125 CONCEALED HINGE**

Thank you for using our product. Before installation, please read this manual thoroughly to ensure correct installation. Please keep this manual at hand for future reference.

ABOUT THE PRODUCT

- Concealed hinges for interior doors.
- Allows vertical, horizontal and depth adjustment.

FOR YOUR SAFETY AND CORRECT INSTALLATION**Meaning of symbols****Warning
Caution****Prohibited****Required****Caution: If not followed, injury or damage may result.**

- ❗ Provide a doorframe that can withstand the weight and impact of opening and closing the door. Be sure to use the specified screws and tighten them securely. If the mounting strength is insufficient, the door may fall and cause injury.
- ⊘ Do not use this product for any other purpose, or with doors that are outside the specifications of this manual.
- ❗ If using a door closer, certain types may cause the door to not close properly or cause damage. Please check the compatibility of the closer before use.
- ❗ Follow the specified dimensions, specifications, and alignment of the door and frame. Warping, tilting or twisting of the frame or door may cause operation failure.
- ❗ This product is a part for architectural fittings. After installation, please check the function and safety of the final product. Please inform the end user how to use the product safely.
- ❗ Make sure to check the screws for slack at regular intervals (one month from first usage, half a year, and then one time every year is recommended).
- ❗ A door stopper must be installed so that the fully open position does not exceed 125°. Failure to do so will result in damage or breakage to the hinges, and the door may fall.

DOOR SPECIFICATION

Min. Door thickness	38 mm
Max. Door weight	50kg per 2 hinges, 65kg per 3 hinges
Max. Door size	Width: 900 mm, Height: 2700 mm

The required quantity of hinges depends on the stiffness and curvature of the door. Install the door and check to determine the appropriate amount of hinges.

INSTALLATION DRAWING (EXAMPLE)

Left-hand opening shown. The right-handed opening is symmetrical.

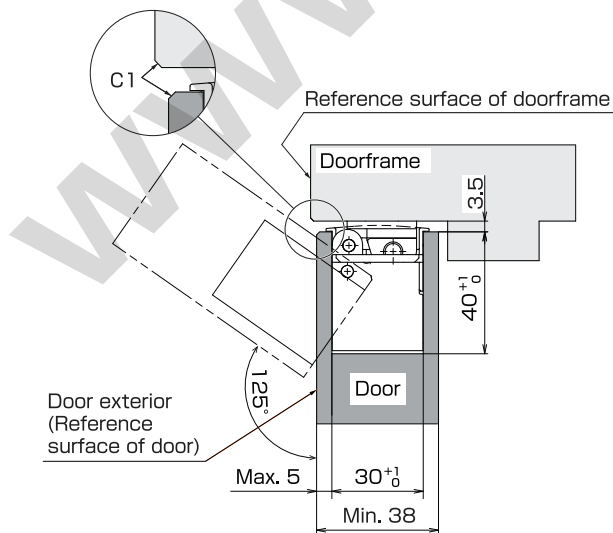
**CUT OUT DRAWING FOR DOOR AND DOORFRAME**

Left-hand opening shown. The right-handed opening is symmetrical.

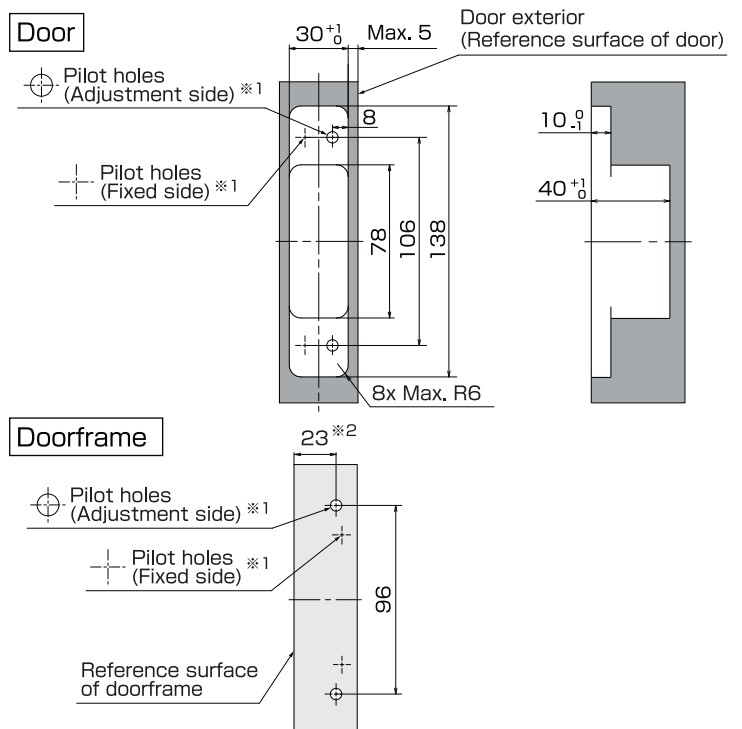

※1 : The diameter and depth of the pilot hole depends on the strength of the timber. Drill pilot holes before installing hinges. The position of the screw on the fixed side depends on the adjusted position of the hinge.

※2 : The value when the machining allowance is 5mm.

COMPONENT PARTS (PER BOX)

Parts	①	② Cover		③	④	⑤	⑥
	Body	Door side	Doorframe side	Distance plate	Adjustment plate	Template	Countersunk head tapping screw 4x20
Quantity	2	2	2	2	2	1	16

INSTALLATION PROCEDURE

Left-hand opening shown. The right-handed opening is symmetrical.

1 Hinge Installation

● Installing Hinge to Door

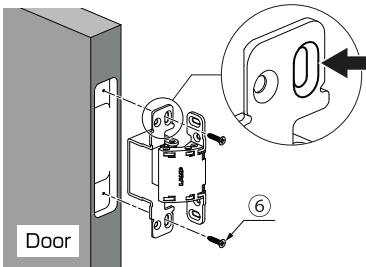

● Installing Hinge to Doorframe

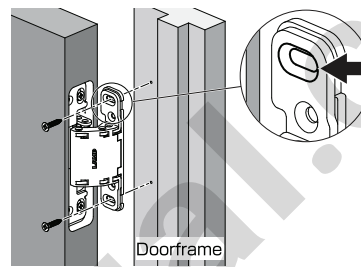
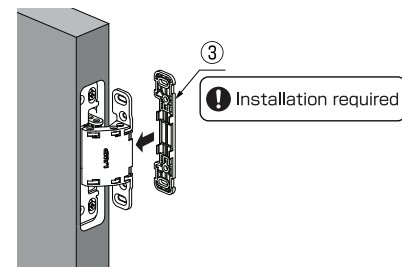

Use supports to support the door

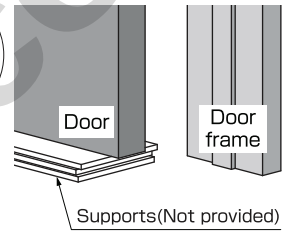

2 Adjusting door position

⚠ Please make sure that the screws are tightened after adjustment.

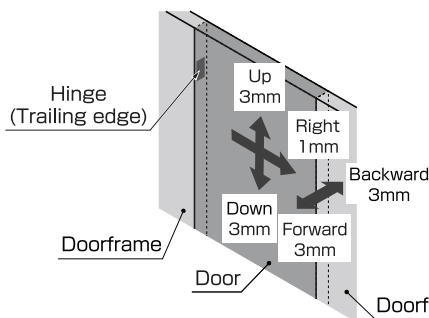

● Vertical adjustment (±3mm)

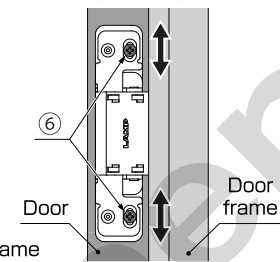

● Horizontal adjustment (+1 mm)

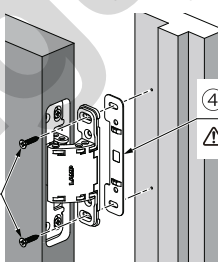

● Depth adjustment (±3mm)

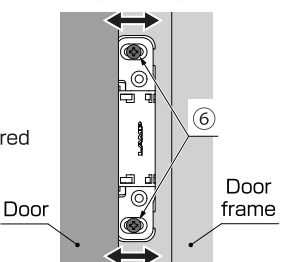

3 Hinge Installation

⚠ Do not skip this step.

● Door side

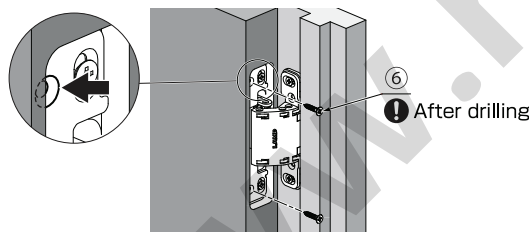

● Doorframe side

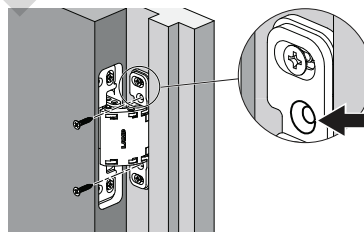

Hanging completed

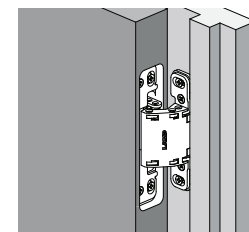

COVER INSTALLATION

● Door side

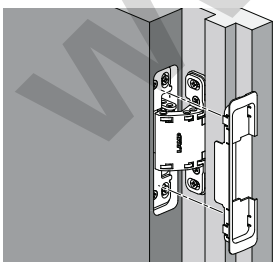

● Doorframe side

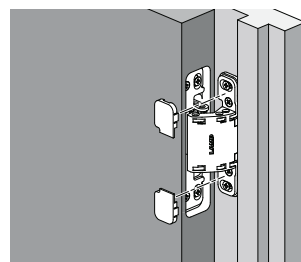

Installation completed

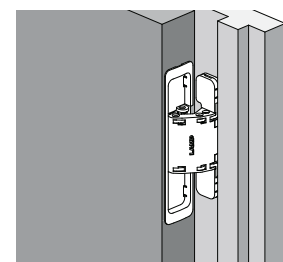

SUGATSUNE KOGYO CO.,LTD

Tokyo, JAPAN
Phone: +81 (0)3 3866 2260 E-mail:export@sugatsune.co.jp

SUGATSUNE KOGYO (UK) LTD

Reading, UK
Phone: +44 118 9272 955 E-mail:sales@sugatsune.co.uk

SUGATSUNE EUROPE GmbH

Düsseldorf, GERMANY
Phone: +49 211 53812900 E-mail:sales@sugatsune.eu
ISO9001(Japan Offices and Sugatsune America) and ISO14001(Chiba Production division and Logistics center), certified.

SUGATSUNE SHANGHAI Co., LTD

Shanghai, CHINA
Phone: +86 21 3632 1858 E-mail:lamp@sugatsune.com.cn

Guangzhou, CHINA

Phone: +86 20 6639 3552 E-mail:lamp@sugatsune.com.cn

SUGATSUNE KOGYO INDIA PRIVATE LIMITED

Mumbai, INDIA
Phone: +91 22 28314490/91 E-mail:sales@sugatsune.in

SUGATSUNE AMERICA, INC

California, USA
Phone: +1 310 329 6373 E-mail:sales@sugatsune.com

Illinois, USA

Phone: +1 630 317 7072 E-mail:sales@sugatsune.com

SUGATSUNE CANADA, INC.

Phone: +1 514 312 5267 E-mail:support@sugatsune.ca