

551H Técnica de encastrar – Extracción parcial – BLUMOTION

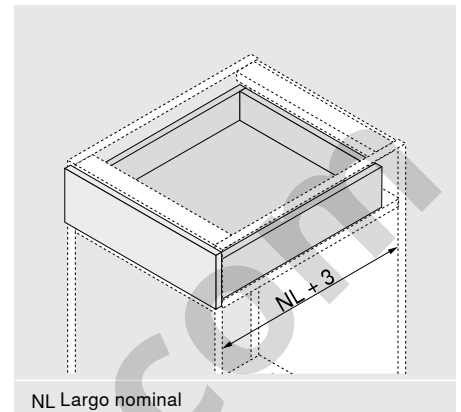

- Guía de extracción parcial TANDEM oculta para cajones de madera con un grosor de panel de 11 a 16 mm
- Con tope final suave en la apertura y tecnología de movimiento BLUMOTION integrada para cierre suave y silencioso
- Adecuado para su uso con SERVO-DRIVE, el sistema eléctrico de apertura asistida
- Los rodillos de teflón resistentes al desgaste aseguran un deslizamiento ultraligero
- Seguro antidesenganche y ajuste de altura integrados en el sistema de guías



NL Largo nominal

Información de pedido

1	Guías lado izquierdo/derecho	
	Largo nominal NL (mm)	30 kg
	260	551H2601B
	285	551H2851B
	310	551H3101B
	335	551H3351B
	360	551H3601B
	385	551H3851B
	410	551H4101B
	435	551H4351B
	460	551H4601B
	485	551H4851B
	510	551H5101B
	535	551H5351B
	560	551H5601B

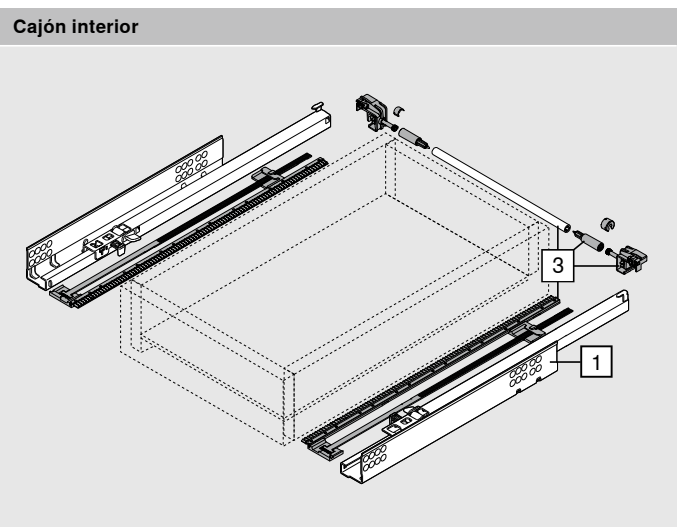
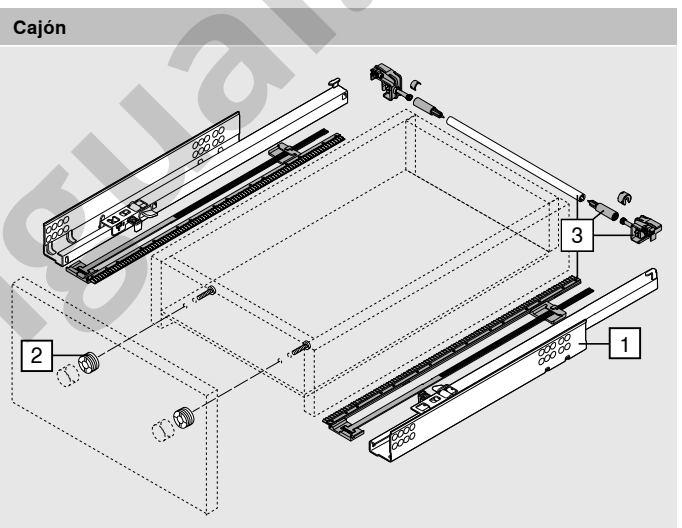

Accesorios

2	Herraje de ajuste del frente		
	Color	Material	
	Color natural	Plástico	295.1000

3	Juego de estabilizadores laterales para extracción parcial		
	Color	Material	
	RAL 7037 gris polvo	Plástico	
	Largo nominal NL (mm)		
	Hasta 410		ZST.410TT
	Hasta 650		ZST.650TT

Apto para anchos de cuerpo de mueble KB 1400 mm

Corte

Ancho interior cuerpo de mueble LW - 222 mm

Largo nominal NL + 12 mm

Advertencia

Con módulos extraíbles anchos con largos nominales cortos, recomendamos utilizar un estabilizador lateral

551H Técnica de encastrar – Extracción parcial – BLUMOTION

Planificación

Espacio ocupado

* +3 mm con estabilizador lateral

Cajón/cajón interior

LW Ancho interior cuerpo de mueble
SKW Ancho interior del cajón

Cajón

NL Largo nominal
SKL Largo del cajón

* Adicionalmente, +12 mm con estabilizador lateral

Cajón interior

ISKL Largo del cajón interior
NL Largo nominal
SKL Largo del cajón
X Espesor del frente

Trabajo del cajón

Utilizar la plantilla de taladrar T65.1000.02

Trabajo del cajón

Largo nominal NL (mm)	Solapa encastrable X2 (mm)	Seguro antidesenganche X1 (mm)
260	205	185
285	220	200
310	230	210
335	245	225
360	275	255
385	285	265
410	300	280
435	310	290
460	335	315
485	350	330
510	360	340
535	375	355
560	405	385

551H Técnica de encastrar – Extracción parcial – TIP-ON



- Guía de extracción parcial TANDEM oculta para cajones de madera con un grosor de panel de 11 a 16 mm
- Con la tecnología de movimiento TIP-ON integrada, el sistema mecánico de apertura asistida
- Los rodillos de teflón resistentes al desgaste aseguran un deslizamiento ultraligero
- Seguro antidesenganche y ajuste de altura integrados en el sistema de guías
- Ajuste de profundidad integrado sin herramientas
- Recomendación: sincronización TIP-ON opcional para una activación segura incluso en frentes anchos

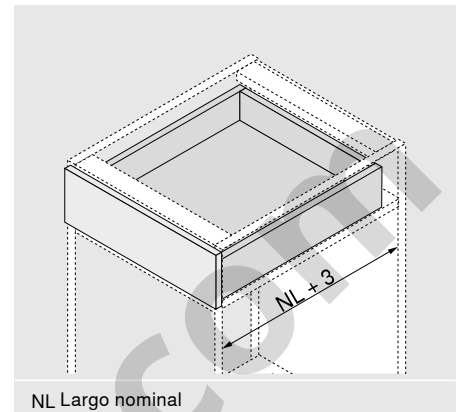

NL Largo nominal

Información de pedido

1	Guías lado izquierdo/derecho	
	Largo nominal NL (mm)	30 kg
	260	551H2601T
	285	551H2851T
	310	551H3101T
	335	551H3351T
	360	551H3601T
	385	551H3851T
	410	551H4101T
	435	551H4351T
	460	551H4601T
	485	551H4851T
	510	551H5101T
	535	551H5351T
	560	551H5601T

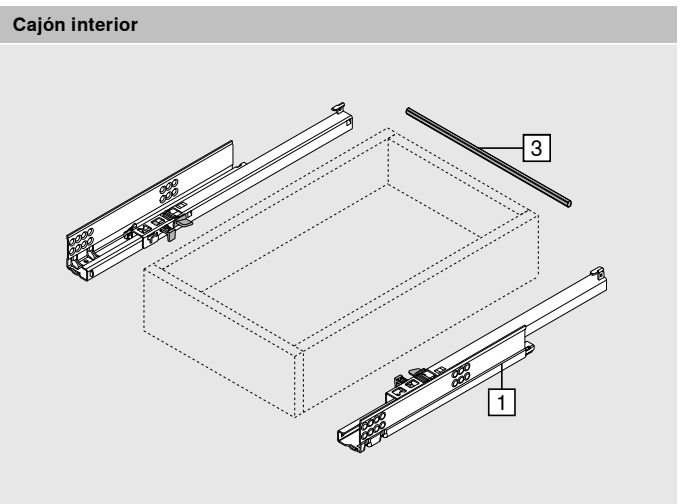
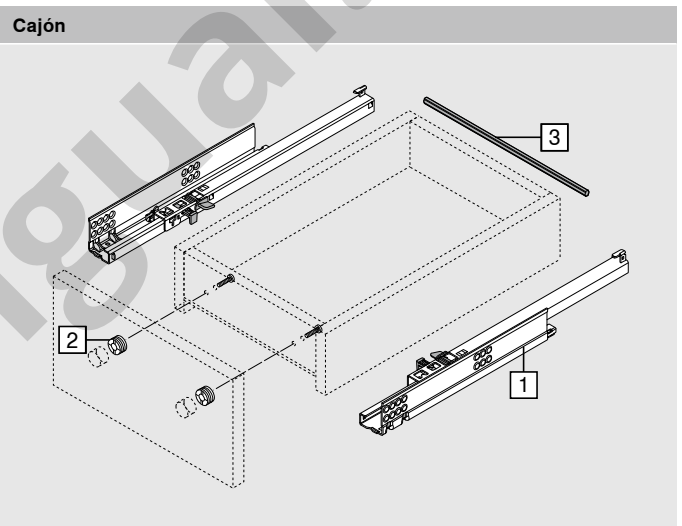

Accesorios

2	Herraje de ajuste del frente		
	Color	Material	
	Color natural	Plástico	295.1000
3	Varilla TIP-ON de sincronización		
	Ancho de cuerpo de mueble KB (mm)	Versión	
	Hasta 1200	Varilla de perfil	T57.1140S
Para cortar a medida			
Recomendamos utilizar una varilla de sincronización para cada ancho de cuerpo de mueble. Corte: ancho interior cuerpo de mueble LW – 31 mm			

551H Técnica de encastrar – Extracción parcial – TIP-ON

Planificación

Espacio ocupado

A Distancia de 3 mm para intercambiar con la extracción total

Cajón/cajón interior

LW Ancho interior cuerpo de mueble
SKW Ancho interior del cajón

Cajón

NL Largo nominal
SKL Largo del cajón

Cajón interior

ISKL Largo del cajón interior
NL Largo nominal
SKL Largo del cajón
X Espesor del frente

Trabajo del cajón

Utilizar la plantilla de taladrar T65.1000.02

Distancia de reacción

Con sincronización
Sin sincronización

Ejemplo para 560H – 30 kg, largo nominal NL 500 mm, cajón de cuatro lados, con sincronización

Trabajo del cajón

Largo nominal NL (mm)	Solapa encastrable X2 (mm)	Seguro antidesenganche X1 (mm)
260	205	185
285	220	200
310	230	210
335	245	225
360	275	255
385	285	265
410	300	280
435	310	290
460	335	315
485	350	330
510	360	340
535	375	355
560	405	385

Accesorios

Herraje de ajuste del frente

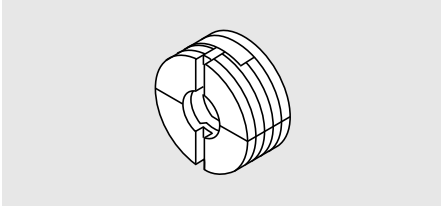

- Con tuerca de acero premontada
- Para cajones de 4 lados
- Ajuste bidimensional del frente (± 2 mm)

Planificación

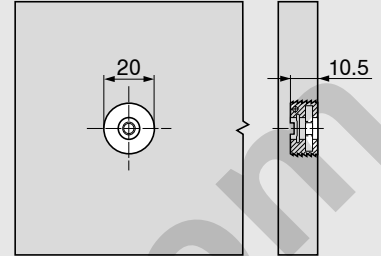

Matrices para MINIPRESS + PRO-CENTER
MZM.0095

Información de pedido

Color	Material	
Color natural	Plástico	295.1000

Juego de estabilizadores laterales para extracción total

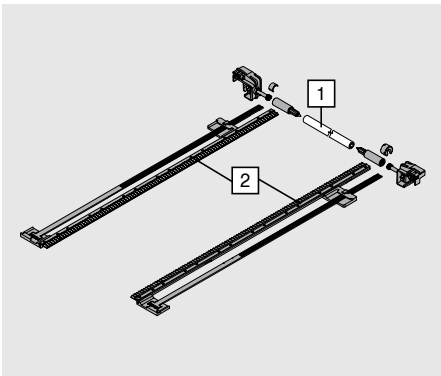

- Para cortar a medida
- Apto para anchos de cuerpo de mueble KB 1400 mm
- Adecuado para:
Guía extracción total TANDEM BLUMOTION 560H | 561H
- Ideal para módulos extraíbles anchos con largos nominales cortos
- No es compatible con TIP-ON

En el caso de módulos extraíbles anchos con largos nominales cortos, recomendamos utilizar un estabilizador lateral.

Información de pedido

Color	Material
RAL 7037 gris polvo	Plástico

Largo nominal NL (mm)

Hasta 410	ZST.410TV
Hasta 600	ZST.600TV
Hasta 750	ZST.750TV

Corte

- 1 Ancho interior cuerpo de mueble LW - 254 mm
- 2 Largo nominal NL + 12 mm

Juego de estabilizadores laterales para extracción parcial

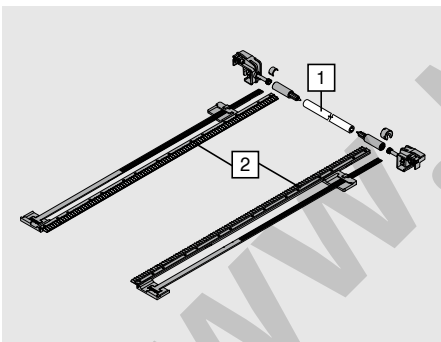

- Para cortar a medida
- Apto para anchos de cuerpo de mueble KB 1400 mm
- Adecuado para:
Guía extracción parcial TANDEM BLUMOTION 550H | 551H
- Ideal para módulos extraíbles anchos con largos nominales cortos
- No es compatible con TIP-ON

En el caso de módulos extraíbles anchos con largos nominales cortos, recomendamos utilizar un estabilizador lateral.

Información de pedido

Color	Material
RAL 7037 gris polvo	Plástico

Largo nominal NL (mm)

Hasta 410	ZST.410TT
Hasta 650	ZST.650TT

Corte

- 1 Ancho interior cuerpo de mueble LW - 222 mm
- 2 Largo nominal NL + 12 mm

Accesorios

POSISTOP

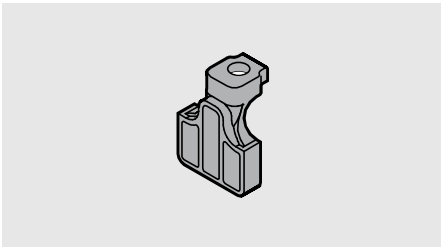

- Tope de profundidad
- Adecuado para:
 - Guía extracción total TANDEM BLUMOTION – 560F
 - Guía extracción parcial TANDEM BLUMOTION – 550F
- Solo se puede combinar con el acoplamiento T51.1700.04
- Solo para aplicaciones internas

Información de pedido	
Color	Material
RAL 7037 gris polvo	Plástico
298.5500	

Soporte guía para entrepaño

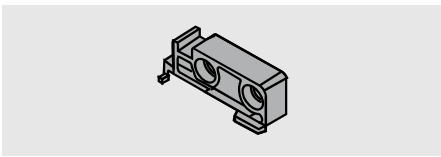

- No es necesario durante el uso del sistema de bloqueo del entrepaño

Información de pedido	
Color	Material
Color natural	Plástico
T51.7000.01	

Sistema de bloqueo del entrepaño

-	Unidad de bloqueo	
	Color	Material
	Gris ori3n mate	Plástico
295.5710		
Pedir para izquierda/derecha		
La fijación solo es posible con tornillos aglo Ø 3,5 x 15 mm, referencia de artículo 609.1500		

-	Elemento de encastre	
	Color	Material
	Gris ori3n mate	Plástico
295H5730		
Fijación con tornillos aglo Ø 3,5 x 15 mm, referencia de artículo 609.1500, o tornillos Euro, referencia de artículo 661.1450.HG		

-	Varilla de sincronización	
	Versión	Material
	Redonda	Aluminio
	Alternativa	
		ZST.1089W
		ZST.1160W
Corte: LW - 87 ± 1 mm		
Sistema de bloqueo del entrepaño desbloqueable con una mano gracias a la sincronización		

Para más información sobre el sistema de bloqueo del entrepaño, véase TD-133 sistema de bloqueo del entrepaño

i

Advertencia

¡Al montar el sistema de bloqueo del entrepaño, asegúrese de que el ajuste de la inclinación quede en el estado de fábrica!



SERVO-DRIVE para TANDEM

Para más información sobre SERVO-DRIVE para TANDEM, véase TD-116 SERVO-DRIVE para MOVENTO y TANDEM



<https://blum.com/CrUe2uyL>













































www.mengual.com

BLUMOTION y TIP-ON

Fijación de las guías 550H/551H

Guía 550H – 30 kg

Largo nominal NL (mm)

NL	19*	37	133	147	165	261	284	325	389
270									
300–450									
500–550									
600									
650									

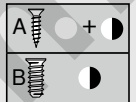









































A Tornillo aglo Ø 4 x 15 mm

B Tornillo Euro Ø 6 x 14.5 mm, referencia de artículo 661.1450.HG

* Puede reemplazarse por tornillo aglo de Ø 4 x 15 mm

Guía 551H – 30 kg

Largo nominal NL (mm)

NL	19*	37	133	147	165	261	284	325
260–285								
310–435								
460–485								
510–535								
560								

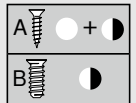

A Tornillo aglo Ø 4 x 15 mm

B Tornillo Euro Ø 6 x 14.5 mm, referencia de artículo 661.1450.HG

* Puede reemplazarse por tornillo aglo de Ø 4 x 15 mm

Técnica de encastrar

Montaje

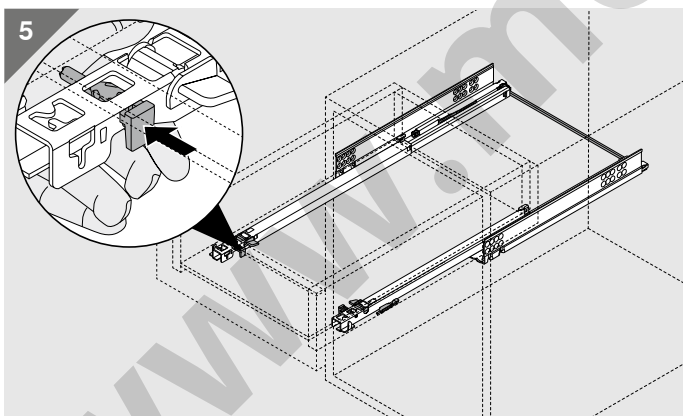
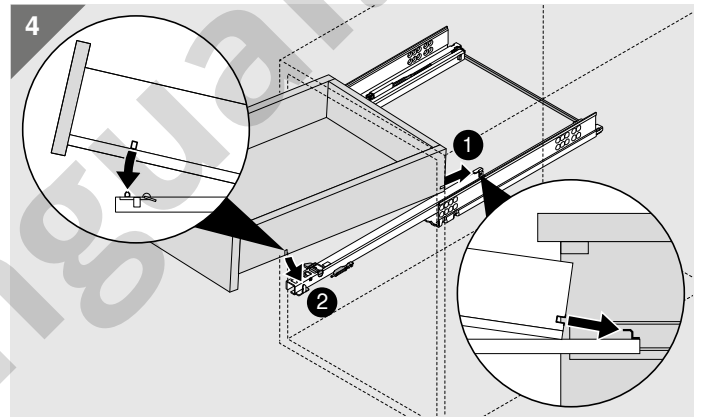
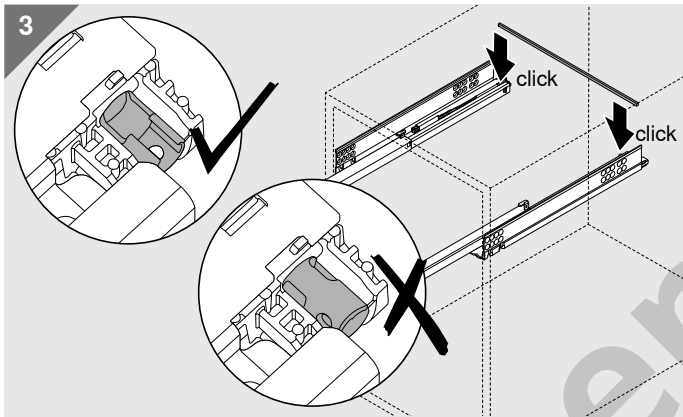
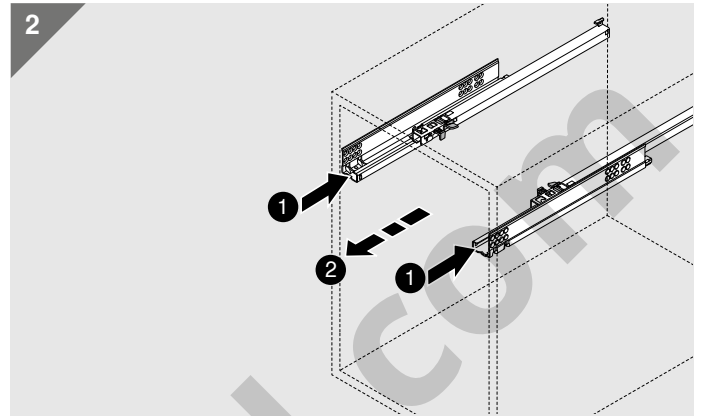
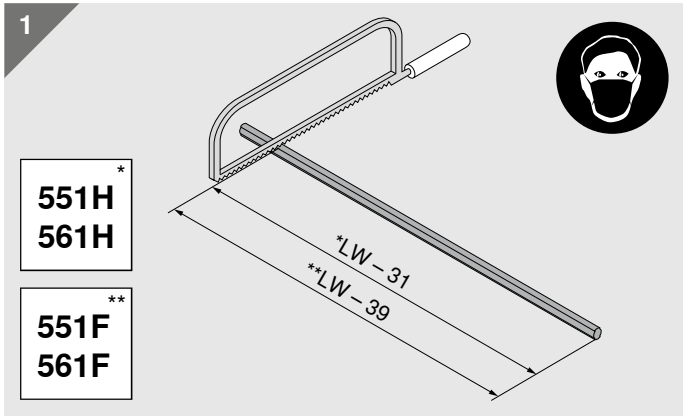

Técnica de encastrar

Ajuste

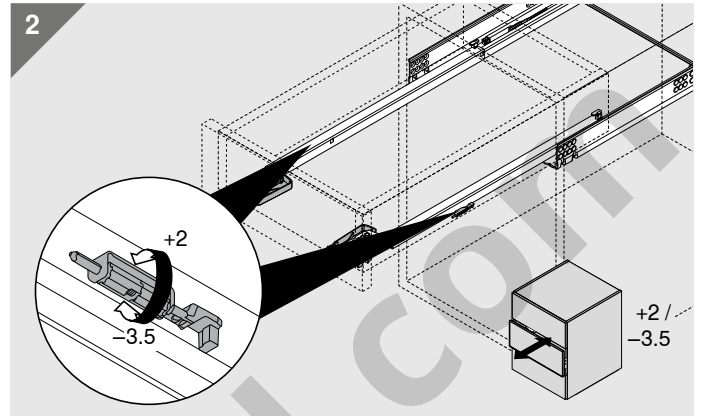
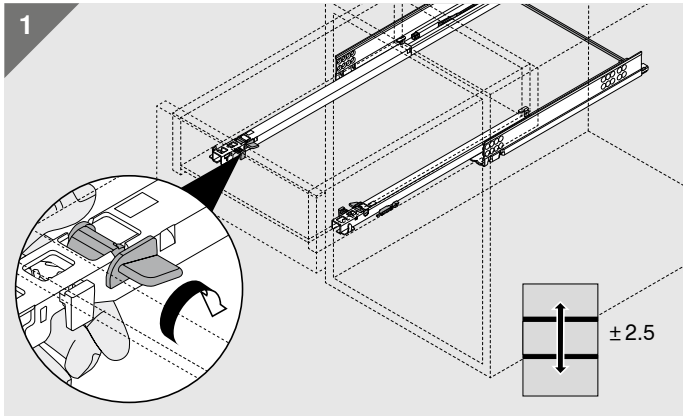

Desmontaje

